

EH 6000 HMT4

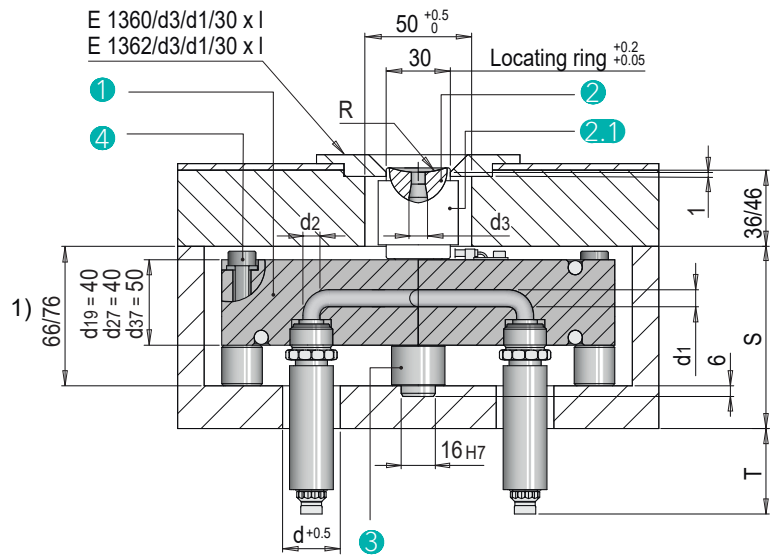

Standardised Hot Runner Manifold screw-in type

- 1 Deflection manifold incl. heating
- 2 EH 6400 sprue bush incl. heating
- 2.1 Sprue bush heater EH 5020
- 3 EH 6200 centering piece
- 4 EH 6214 titanium spacer and screw set
- 5 Anti-rotation pin E 1300
- 6 EH 52001 90° bent thermocouple
- 7 EH 5220 pipe heater connection set
- 7.1 Connecting cable
- 7.2 Connector clamp
- 8 Grounding cable EH 5230
- 9 EH 4100 hot runner nozzle



Note: the hole patterns A are based on the mould dimensions.
The linear expansion is calculated by Meusburger.

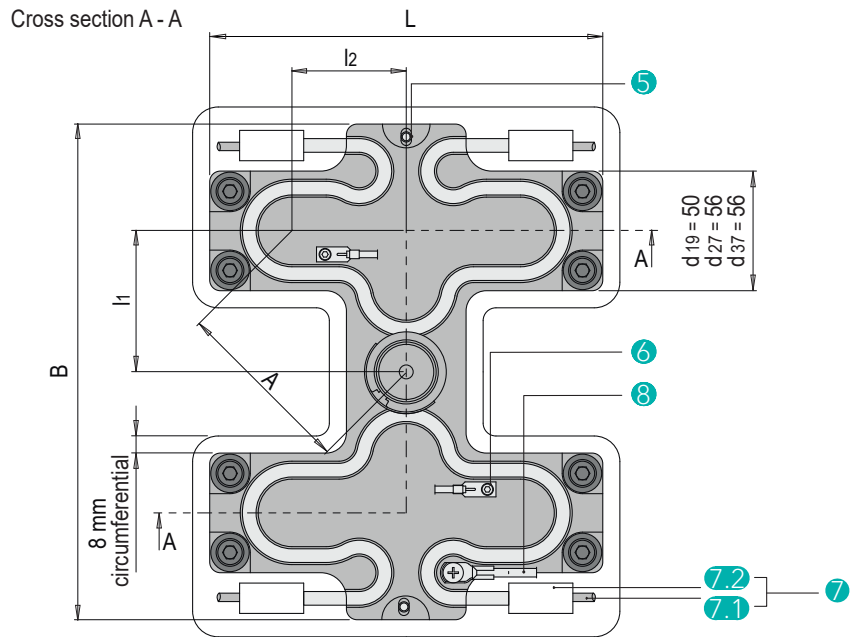

1) Plate thickness depends on hot runner manifold height

Item	L	B	l1 (min.-max.)	l2 (min.-max.)	d1	d2	d3	S (min.-max.)	T (min.-max.)	R	CP ²⁾	Power total watts	Manifold heater item no.	d	Type
EH 6000/ HMT4	159	= 2 x l1 + 100	40 - 66	25 - 43.75	6	5	6	86 - 116	15 - 160	0	2	230V / 2400 W	4x EH 5030/MH-FLEX/ 6,5x 375/600/230	19	
					8	8	10							27	
	184	> 56.25	6	5	6	8	8	10	0	15.5	230V / 2800 W	4x EH 5030/MH-FLEX/ 6,5x 425/700/230	19		
													27		
	209	> 68.75	6	5	6	8	8	10	0	15.5	230V / 3200 W	4x EH 5030/MH-FLEX/ 6,5x 475/800/230	19		
													27		
	234	> 81.25	6	5	6	8	8	10	0	15.5	230V / 3600 W	4x EH 5030/MH-FLEX/ 6,5x 525/900/230	19		
													27		
	259	> 93.75	6	5	6	8	8	10	0	15.5	230V / 3900 W	4x EH 5030/MH-FLEX/ 6,5x 575/975/230	19		
													27		
	284	> 106.25	6	5	6	8	8	10	0	15.5	230V / 4100 W	4x EH 5030/MH-FLEX/ 6,5x 625/1025/230	19		
													27		
309	> 118.75	6	5	6	8	8	10	0	15.5	230V / 4300 W	4x EH 5030/MH-FLEX/ 6,5x 675/1075/230	19			
												27			

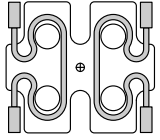
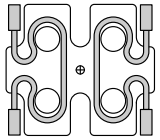
Item	L	B	I1 (min.-max.)	I2 (min.-max.)	d1	d2	d3	S (min.-max.)	T (min.-max.)	R	CP ²⁾	Power total watts	Manifold heater item no.	d	Type					
EH 6000/ HMT4	334	= 2 x I1 + 100	40 - 66	> 118.75 - 131.25	6	5	6	86 - 116	15 - 160	0	2	230V / 4500 W	4x EH 5030/MH-FLEX/ 6,5x 725/1125/230	19						
					8	8	10			15.5				27						
	359	> 131.25 - 143.75	6	5	6	0	230V / 4700 W			4x EH 5030/MH-FLEX/ 6,5x 775/1175/230		19								
			8	8	10	15.5						27								
	384	> 143.75 - 156.25	6	5	6	0	230V / 4900 W			4x EH 5030/MH-FLEX/ 6,5x 825/1225/230		19								
			8	8	10	15.5						27								
	409	> 156.25 - 168.75	6	5	6	0	230V / 5100 W			4x EH 5030/MH-FLEX/ 6,5x 875/1275/230		19								
			8	8	10	15.5						27								
	434	> 168.75 - 181.25	6	5	6	0	230V / 5300 W			4x EH 5030/MH-FLEX/ 6,5x 925/1325/230		19								
			8	8	10	15.5						27								
	459	> 181.25 - 193.75	6	5	6	0	230V / 5500 W			4x EH 5030/MH-FLEX/ 6,5x 975/1375/230		19								
			8	8	10	15.5						27								
	484	> 193.75 - 206.25	6	5	6	0	230V / 5700 W			4x EH 5030/MH-FLEX/ 6,5x 1025/1425/230		19								
			8	8	10	15.5						27								
	EH 6000/ HMT4	159	= 2 x I1 + 100	40 - 66	37,5 - 43.75	12	12			12		86 - 116	15 - 160	0		2	230V / 2600 W	4x EH 5030/MH-FLEX/ 6,5 x 400/650/230	37	
						15.5	40													
		184	> 56.25	0	230V / 3000 W	4x EH 5030/MH-FLEX/ 6,5 x 450/750/230	15.5			40										
				0																
		209	> 68.75	0	230V / 3400 W	4x EH 5030/MH-FLEX/ 6,5 x 500/850/230	15.5			40										
				0																
		234	> 81.25	0	230V / 3800 W	4x EH 5030/MH-FLEX/ 6,5 x 550/950/230	15.5			40										
				0																
		259	> 93.75	0	230V / 4000 W	4x EH 5030/MH-FLEX/ 6,5 x 600/1000/230	15.5			40										
				0																
284		> 106.25	0	230V / 4200 W	4x EH 5030/MH-FLEX/ 6,5 x 650/1050/230	15.5	40													
			0																	
309		> 118.75	0	230V / 4400 W	4x EH 5030/MH-FLEX/ 6,5 x 700/1100/230	15.5	40													
			0																	
334		> 118.75 - 131.25	0	230V / 4600 W	4x EH 5030/MH-FLEX/ 6,5 x 750/1150/230	15.5	40													
			0																	
359		> 131.25 - 143.75	0	230V / 4800 W	4x EH 5030/MH-FLEX/ 6,5 x 800/1200/230	15.5	40													
			0																	
384		> 143.75 - 156.25	0	230V / 5000 W	4x EH 5030/MH-FLEX/ 6,5 x 850/1250/230	15.5	40													
			0																	
409		> 156.25 - 168.75	0	230V / 5200 W	4x EH 5030/MH-FLEX/ 6,5 x 900/1300/230	15.5	40													
			0																	
434		> 168.75 - 181.25	0	230V / 5400 W	4x EH 5030/MH-FLEX/ 6,5 x 950/1350/230	15.5	40													
			0																	
459	> 181.25 - 193.75	0	230V / 5600 W	4x EH 5030/MH-FLEX/ 6,5 x 1000/1400/230	15.5	40														
		0																		
484	> 193.75 - 206.25	0	230V / 5800 W	4x EH 5030/MH-FLEX/ 6,5 x 1050/1450/230	15.5	40														
		0																		

2) CP: Control points of hot runner manifold

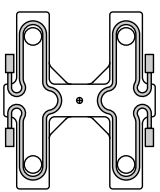
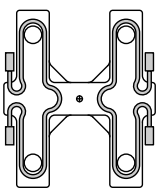
Item	L	B	I1 (min.-max.)	I2 (min.-max.)	d1	d2	d3	S (min.-max.)	T (min.-max.)	R	CP ²⁾	Power total watts	Manifold heater item no.	d	Type
EH 6000/ HMT4	159	= 2 x I1 + 100	> 66 - 80	25 - 43.75	6	5	6	86 - 116	15 - 160	0	2	230V / 2600 W	4x EH 5030/MH-FLEX/ 6,5 x 400/650/230	19	
					8	8	10			15.5				27	
	184	> 43.75 - 56.25	6	5	6	0	230V / 3000 W			4x EH 5030/MH-FLEX/ 6,5 x 450/750/230		19			
			8	8	10	15.5						27			
	209	> 56.25 - 68.75	6	5	6	0	230V / 3400 W			4x EH 5030/MH-FLEX/ 6,5 x 500/850/230		19			
			8	8	10	15.5						27			
	234	> 68.75 - 81.25	6	5	6	0	230V / 3800 W			4x EH 5030/MH-FLEX/ 6,5 x 550/950/230		19			
			8	8	10	15.5						27			
	259	> 81.25 - 93.75	6	5	6	0	230V / 4000 W			4x EH 5030/MH-FLEX/ 6,5 x 600/1000/230		19			
			8	8	10	15.5						27			
	284	> 93.75 - 106.25	6	5	6	0	230V / 4200 W			4x EH 5030/MH-FLEX/ 6,5 x 650/1050/230		19			
			8	8	10	15.5						27			
	309	> 106.25 - 118.75	6	5	6	0	230V / 4400 W			4x EH 5030/MH-FLEX/ 6,5 x 700/1100/230		19			
			8	8	10	15.5						27			
	334	> 118.75 - 131.25	6	5	6	0	230V / 4600 W			4x EH 5030/MH-FLEX/ 6,5 x 750/1150/230		19			
			8	8	10	15.5						27			
	359	> 131.25 - 143.75	6	5	6	0	230V / 4800 W			4x EH 5030/MH-FLEX/ 6,5 x 800/1200/230		19			
			8	8	10	15.5						27			
	384	> 143.75 - 156.25	6	5	6	0	230V / 5000 W			4x EH 5030/MH-FLEX/ 6,5 x 850/1250/230		19			
			8	8	10	15.5						27			
409	> 156.25 - 168.75	6	5	6	0	230V / 5200 W	4x EH 5030/MH-FLEX/ 6,5 x 900/1300/230	19							
		8	8	10	15.5			27							
434	> 168.75 - 181.25	6	5	6	0	230V / 5400 W	4x EH 5030/MH-FLEX/ 6,5 x 950/1350/230	19							
		8	8	10	15.5			27							
459	> 181.25 - 193.75	6	5	6	0	230V / 5600 W	4x EH 5030/MH-FLEX/ 6,5 x 1000/1400/230	19							
		8	8	10	15.5			27							
484	> 193.75 - 206.25	6	5	6	0	230V / 5800 W	4x EH 5030/MH-FLEX/ 6,5 x 1050/1450/230	19							
		8	8	10	15.5			27							
EH 6000/ HMT4	159	= 2 x I1 + 100	> 66 - 80	37,5 - 43.75	12	12	12	86 - 116	15 - 160	0	2	230V / 2800 W	4x EH 5030/MH-FLEX/ 6,5x 425/700/230	37	
					15.5	27									
					40										
					0	230V / 3200 W	4x EH 5030/MH-FLEX/ 6,5x 475/800/230			19					
					15.5					27					
					40										
					0	230V / 3600 W	4x EH 5030/MH-FLEX/ 6,5x 525/900/230			19					
					15.5					27					
40															
0	230V / 3900 W	4x EH 5030/MH-FLEX/ 6,5x 575/975/230	19												
15.5			27												
40															
0	230V / 4100 W	4x EH 5030/MH-FLEX/ 6,5x 625/1025/230	19												
15.5			27												
40															
0	230V / 4300 W	4x EH 5030/MH-FLEX/ 6,5x 675/1075/230	19												
15.5			27												
40															
0	230V / 4500 W	4x EH 5030/MH-FLEX/ 6,5x 725/1125/230	19												
15.5			27												
40															

2) CP: Control points of hot runner manifold

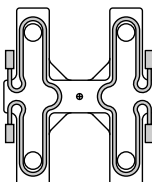
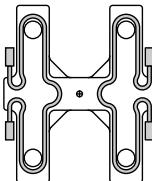
Item	L	B	I1 (min.-max.)	I2 (min.-max.)	d1	d2	d3	S (min.-max.)	T (min.-max.)	R	CP ²⁾	Power total watts	Manifold heater item no.	d	Type
EH 6000/ HMT4	334	= 2 x I1 + 100	> 66 - 80	> 118.75 - 131.25	12	12	12	86 - 116	15 - 160	0	2	230V / 4700 W	4x EH 5030/MH-FLEX/ 6,5x 775/1175/230	37	
	15.5														
	40														
	0														
	15.5														
	40														
	0														
	15.5														
40															
359	> 131.25 - 143.75	0	230V / 4900 W	4x EH 5030/MH-FLEX/ 6,5x 825/1225/230											
15.5															
40															
0															
15.5															
40															
384	> 143.75 - 156.25	0	230V / 5100 W	4x EH 5030/MH-FLEX/ 6,5x 875/1275/230											
15.5															
40															
0															
15.5															
40															
409	> 156.25 - 168.75	0	230V / 5300 W	4x EH 5030/MH-FLEX/ 6,5x 925/1325/230											
15.5															
40															
0															
15.5															
40															
434	> 168.75 - 181.25	0	230V / 5500 W	4x EH 5030/MH-FLEX/ 6,5x 975/1375/230											
15.5															
40															
0															
15.5															
40															
459	> 181.25 - 193.75	0	230V / 5700 W	4x EH 5030/MH-FLEX/ 6,5x 1025/1425/230											
15.5															
40															
0															
15.5															
40															
484	> 193.75 - 206.25	0	230V / 5900 W	4x EH 5030/MH-FLEX/ 6,5 x 1075/1475/230											
15.5															
40															
0															
15.5															
40															
EH 6000/ HMT4	159	= 2 x I1 + 100	> 80 - 92,5	25 - 43.75	6	5	6	86 - 116	15 - 160	0	2	230V / 2800 W	4x EH 5030/MH-FLEX/ 6,5x 425/700/230	19	
										15.5					
	40														
	0														
	15.5														
	40														
	0														
	15.5														
	40														
	184			> 43.75 - 56.25						0		230V / 3200 W	4x EH 5030/MH-FLEX/ 6,5x 475/800/230		
	15.5														
	40														
	0														
	15.5														
	40														
	209			> 56.25 - 68.75						0		230V / 3600 W	4x EH 5030/MH-FLEX/ 6,5x 525/900/230		
	15.5														
	40														
	0														
	15.5														
	40														
	234			> 68.75 - 81.25						0		230V / 3900 W	4x EH 5030/MH-FLEX/ 6,5x 575/975/230		
	15.5														
	40														
0															
15.5															
40															
259	> 81.25 - 93.75	0	230V / 4100 W	4x EH 5030/MH-FLEX/ 6,5x 625/1025/230											
15.5															
40															
0															
15.5															
40															
284	> 93.75 - 106.25	0	230V / 4300 W	4x EH 5030/MH-FLEX/ 6,5x 675/1075/230											
15.5															
40															
0															
15.5															
40															
309	> 106.25 - 118.75	0	230V / 4500 W	4x EH 5030/MH-FLEX/ 6,5x 725/1125/230											
15.5															
40															
0															
15.5															
40															
334	> 118.75 - 131.25	0	230V / 4700 W	4x EH 5030/MH-FLEX/ 6,5x 775/1175/230											
15.5															
40															
0															
15.5															
40															
359	> 131.25 - 143.75	0	230V / 4900 W	4x EH 5030/MH-FLEX/ 6,5x 825/1225/230											
15.5															
40															
0															
15.5															
40															
384	> 143.75 - 156.25	0	230V / 5100 W	4x EH 5030/MH-FLEX/ 6,5x 875/1275/230											
15.5															
40															
0															
15.5															
40															
409	> 156.25 - 168.75	0	230V / 5300 W	4x EH 5030/MH-FLEX/ 6,5x 925/1325/230											
15.5															
40															
0															
15.5															
40															
434	> 168.75 - 181.25	0	230V / 5500 W	4x EH 5030/MH-FLEX/ 6,5x 975/1375/230											
15.5															
40															
0															
15.5															
40															
459	> 181.25 - 193.75	0	230V / 5700 W	4x EH 5030/MH-FLEX/ 6,5x 1025/1425/230											
15.5															
40															
0															
15.5															
40															
484	> 193.75 - 206.25	0	230V / 5900 W	4x EH 5030/MH-FLEX/ 6,5 x 1075/1475/230											
15.5															
40															
0															
15.5															
40															

2) CP: Control points of hot runner manifold

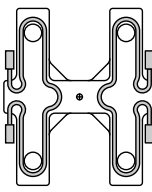
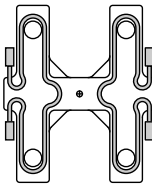
Item	L	B	I1 (min.-max.)	I2 (min.-max.)	d1	d2	d3	S (min.-max.)	T (min.-max.)	R	CP ²⁾	Power total watts	Manifold heater item no.	d	Type
EH 6000/ HMT4	334	= 2 x I1 + 100	> 92,5 - 110	> 118.75 - 131.25	6	5	6	86 - 116	15 - 160	0	2	230V / 4800 W	4x EH 5030/MH-FLEX/ 6,5 x 800/1200/230	19	
					8	8	10			15.5				27	
	359	> 131.25 - 143.75		6	5	6	0			230V / 5000 W		4x EH 5030/MH-FLEX/ 6,5 x 850/1250/230	19		
				8	8	10	15.5						27		
	384	> 143.75 - 156.25		6	5	6	0			230V / 5200 W		4x EH 5030/MH-FLEX/ 6,5 x 900/1300/230	19		
				8	8	10	15.5						27		
	409	> 156.25 - 168.75		6	5	6	0			230V / 5400 W		4x EH 5030/MH-FLEX/ 6,5 x 950/1350/230	19		
				8	8	10	15.5						27		
	434	> 168.75 - 181.25		6	5	6	0			230V / 5600 W		4x EH 5030/MH-FLEX/ 6,5 x 1000/1400/230	19		
				8	8	10	15.5						27		
	459	> 181.25 - 193.75		6	5	6	0			230V / 5800 W		4x EH 5030/MH-FLEX/ 6,5 x 1050/1450/230	19		
				8	8	10	15.5						27		
	484	> 193.75 - 206.25		6	5	6	0			230V / 6000 W		4x EH 5030/MH-FLEX/ 6,5 x 1100/1500/230	19		
				8	8	10	15.5						27		
EH 6000/ HMT4	159	= 2 x I1 + 100	> 92,5 - 110	37,5 - 43.75	12	12	12	86 - 116	15 - 160	0	2	230V / 3200 W	4x EH 5030/MH-FLEX/ 6,5 x 475/800/230	37	
					15.5	40									
	184	> 43.75 - 56.25		0	230V / 3600 W	4x EH 5030/MH-FLEX/ 6,5 x 525/900/230	15.5			37					
				40											
	209	> 56.25 - 68.75		0	230V / 3900 W	4x EH 5030/MH-FLEX/ 6,5 x 575/975/230	15.5			37					
				40											
	234	> 68.75 - 81.25		0	230V / 4100 W	4x EH 5030/MH-FLEX/ 6,5 x 625/1025/230	15.5			37					
				40											
	259	> 81.25 - 93.75		0	230V / 4300 W	4x EH 5030/MH-FLEX/ 6,5 x 675/1075/230	15.5			37					
				40											
	284	> 93.75 - 106.25		0	230V / 4500 W	4x EH 5030/MH-FLEX/ 6,5 x 725/1125/230	15.5			37					
				40											
	309	> 106.25 - 118.75		0	230V / 4700 W	4x EH 5030/MH-FLEX/ 6,5 x 775/1175/230	15.5			37					
				40											
334	> 118.75 - 131.25	0	230V / 4900 W	4x EH 5030/MH-FLEX/ 6,5 x 825/1225/230	15.5	37									
		40													
359	> 131.25 - 143.75	0	230V / 5100 W	4x EH 5030/MH-FLEX/ 6,5 x 875/1275/230	15.5	37									
		40													
384	> 143.75 - 156.25	0	230V / 5300 W	4x EH 5030/MH-FLEX/ 6,5 x 925/1325/230	15.5	37									
		40													
409	> 156.25 - 168.75	0	230V / 5500 W	4x EH 5030/MH-FLEX/ 6,5 x 975/1375/230	15.5	37									
		40													
434	> 168.75 - 181.25	0	230V / 5700 W	4x EH 5030/MH-FLEX/ 6,5 x 1025/1425/230	15.5	37									
		40													
459	> 181.25 - 193.75	0	230V / 5900 W	4x EH 5030/MH-FLEX/ 6,5 x 1075/1475/230	15.5	37									
		40													
484	> 193.75 - 206.25	0	230V / 6000 W	4x EH 5030/MH-FLEX/ 6,5 x 1100/1500/230	15.5	37									
		40													

2) CP: Control points of hot runner manifold

Item	L	B	I1 (min.-max.)	I2 (min.-max.)	d1	d2	d3	S (min.-max.)	T (min.-max.)	R	CP ²⁾	Power total watts	Manifold heater item no.	d	Type
EH 6000/ HMT4	159	= 2 x I1 + 100	> 110 - 122,5	25 - 43.75	6	5	6	86 - 116	15 - 160	0	3	230V / 3500 W	4x EH 5030/MH-FLEX/ 6,5x 375/600/230 2x EH 5030/MH-FLEX/ 6,5x 350/550/230	19	
	15.5														
	40														
	0			230V / 3900 W						4x EH 5030/MH-FLEX/ 6,5x 425/700/230 2x EH 5030/MH-FLEX/ 6,5x 350/550/230					
	15.5														
	40														
	0			230V / 4300 W						4x EH 5030/MH-FLEX/ 6,5x 475/800/230 2x EH 5030/MH-FLEX/ 6,5x 350/550/230					
	15.5														
	40														
	0			230V / 4700 W						4x EH 5030/MH-FLEX/ 6,5x 525/900/230 2x EH 5030/MH-FLEX/ 6,5x 350/550/230					
	15.5														
	40														
	0			230V / 5000 W						4x EH 5030/MH-FLEX/ 6,5x 575/975/230 2x EH 5030/MH-FLEX/ 6,5x 350/550/230					
	15.5														
	40														
	0			230V / 5200 W						4x EH 5030/MH-FLEX/ 6,5x 625/1025/230 2x EH 5030/MH-FLEX/ 6,5x 350/550/230					
15.5															
40															
0	230V / 5400 W	4x EH 5030/MH-FLEX/ 6,5x 675/1075/230 2x EH 5030/MH-FLEX/ 6,5x 350/550/230													
15.5															
40															
0	230V / 5600 W	4x EH 5030/MH-FLEX/ 6,5x 725/1125/230 2x EH 5030/MH-FLEX/ 6,5x 350/550/230													
15.5															
40															
0	230V / 5800 W	4x EH 5030/MH-FLEX/ 6,5x 775/1175/230 2x EH 5030/MH-FLEX/ 6,5x 350/550/230													
15.5															
40															
0	230V / 6000 W	4x EH 5030/MH-FLEX/ 6,5x 825/1225/230 2x EH 5030/MH-FLEX/ 6,5x 350/550/230													
15.5															
40															
0	230V / 6200 W	4x EH 5030/MH-FLEX/ 6,5x 875/1275/230 2x EH 5030/MH-FLEX/ 6,5x 350/550/230													
15.5															
40															
0	230V / 6400 W	4x EH 5030/MH-FLEX/ 6,5x 925/1325/230 2x EH 5030/MH-FLEX/ 6,5x 350/550/230													
15.5															
40															
0	230V / 6600 W	4x EH 5030/MH-FLEX/ 6,5x 975/1375/230 2x EH 5030/MH-FLEX/ 6,5x 350/550/230													
15.5															
40															
0	230V / 6800 W	4x EH 5030/MH-FLEX/ 6,5x 1025/1425/230 2x EH 5030/MH-FLEX/ 6,5x 350/550/230													
15.5															
40															
EH 6000/ HMT4	159	= 2 x I1 + 100	> 122,5 - 135	25 - 43.75	6	5	6	86 - 116	15 - 160	0	3	230V / 3700 W	4x EH 5030/MH-FLEX/ 6,5x 375/600/230 2x EH 5030/MH-FLEX/ 6,5x 400/650/230	19	
	15.5														
	40														
	0			230V / 4100 W						4x EH 5030/MH-FLEX/ 6,5x 425/700/230 2x EH 5030/MH-FLEX/ 6,5x 400/650/230					
	15.5														
	40														
	0			230V / 4500 W						4x EH 5030/MH-FLEX/ 6,5x 475/800/230 2x EH 5030/MH-FLEX/ 6,5x 400/650/230					
	15.5														
40															
0	230V / 4900 W	4x EH 5030/MH-FLEX/ 6,5x 525/900/230 2x EH 5030/MH-FLEX/ 6,5x 400/650/230													
15.5															
40															
0	230V / 5200 W	4x EH 5030/MH-FLEX/ 6,5x 575/975/230 2x EH 5030/MH-FLEX/ 6,5x 400/650/230													
15.5															
40															
0	230V / 5400 W	4x EH 5030/MH-FLEX/ 6,5x 625/1025/230 2x EH 5030/MH-FLEX/ 6,5x 400/650/230													
15.5															
40															
0	230V / 5600 W	4x EH 5030/MH-FLEX/ 6,5x 675/1075/230 2x EH 5030/MH-FLEX/ 6,5x 400/650/230													
15.5															
40															

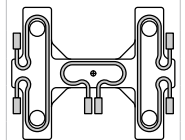
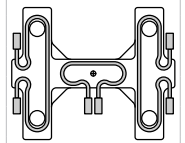

2) CP: Control points of hot runner manifold

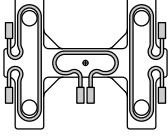
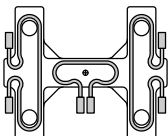
Item	L	B	I1 (min.-max.)	I2 (min.-max.)	d1	d2	d3	S (min.-max.)	T (min.-max.)	R	CP ²⁾	Power total watts	Manifold heater item no.	d	Type
EH 6000/ HMT4	334	= 2 x I1 + 100	> 122,5 - 135	> 118.75 - 131.25	6	5	6	86 - 116	15 - 160	0	3	230V / 5800 W	4x EH 5030/MH-FLEX/ 6,5x 725/1125/230 2x EH 5030/MH-FLEX/ 6,5x 400/650/230	19	
	15.5														
	40			0						230V / 6000 W	4x EH 5030/MH-FLEX/ 6,5x 775/1175/230 2x EH 5030/MH-FLEX/ 6,5x 400/650/230				
	0														
	15.5			0						230V / 6200 W	4x EH 5030/MH-FLEX/ 6,5x 825/1225/230 2x EH 5030/MH-FLEX/ 6,5x 400/650/230				
	40														
	359			> 131.25 - 143.75						0	230V / 6400 W	4x EH 5030/MH-FLEX/ 6,5x 875/1275/230 2x EH 5030/MH-FLEX/ 6,5x 400/650/230			
	0														
384	> 143.75 - 156.25	15.5	230V / 6600 W	4x EH 5030/MH-FLEX/ 6,5x 925/1325/230 2x EH 5030/MH-FLEX/ 6,5x 400/650/230											
40															
409	> 156.25 - 168.75	0	230V / 6800 W	4x EH 5030/MH-FLEX/ 6,5x 975/1375/230 2x EH 5030/MH-FLEX/ 6,5x 400/650/230											
15.5															
434	> 168.75 - 181.25	40	230V / 7000 W	4x EH 5030/MH-FLEX/ 6,5x 1025/1425/230 2x EH 5030/MH-FLEX/ 6,5x 400/650/230											
0															
459	> 181.25 - 193.75	15.5	230V / 7200 W	4x EH 5030/MH-FLEX/ 6,5x 1025/1425/230 2x EH 5030/MH-FLEX/ 6,5x 400/650/230											
40															
484	> 193.75 - 206.25	0													
EH 6000/ HMT4	159	= 2 x I1 + 100	> 135 - 147,5	25 - 43.75	6	5	6	86 - 116	15 - 160	0	3	230V / 3900 W	4x EH 5030/MH-FLEX/ 6,5x 375/600/230 2x EH 5030/MH-FLEX/ 6,5x 450/750/230	19	
	15.5														
	40			0						230V / 4300 W	4x EH 5030/MH-FLEX/ 6,5x 425/700/230 2x EH 5030/MH-FLEX/ 6,5x 450/750/230				
	0														
	15.5			0						230V / 4700 W	4x EH 5030/MH-FLEX/ 6,5x 475/800/230 2x EH 5030/MH-FLEX/ 6,5x 450/750/230				
	40														
	184			> 43.75 - 56.25						15.5	230V / 5100 W	4x EH 5030/MH-FLEX/ 6,5x 525/900/230 2x EH 5030/MH-FLEX/ 6,5x 450/750/230			
	40														
	209			> 56.25 - 68.75						0	230V / 5400 W	4x EH 5030/MH-FLEX/ 6,5x 575/975/230 2x EH 5030/MH-FLEX/ 6,5x 450/750/230			
	15.5														
	234			> 68.75 - 81.25						40	230V / 5600 W	4x EH 5030/MH-FLEX/ 6,5x 625/1025/230 2x EH 5030/MH-FLEX/ 6,5x 450/750/230			
	0														
	259			> 81.25 - 93.75						15.5	230V / 5800 W	4x EH 5030/MH-FLEX/ 6,5x 675/1075/230 2x EH 5030/MH-FLEX/ 6,5x 450/750/230			
	40														
	284			> 93.75 - 106.25						0	230V / 6000 W	4x EH 5030/MH-FLEX/ 6,5x 725/1125/230 2x EH 5030/MH-FLEX/ 6,5x 450/750/230			
	15.5														
309	> 106.25 - 118.75	40	230V / 6200 W	4x EH 5030/MH-FLEX/ 6,5x 775/1175/230 2x EH 5030/MH-FLEX/ 6,5x 450/750/230											
0															
334	> 118.75 - 131.25	15.5	230V / 6400 W	4x EH 5030/MH-FLEX/ 6,5x 825/1225/230 2x EH 5030/MH-FLEX/ 6,5x 450/750/230											
40															
359	> 131.25 - 143.75	0	230V / 6600 W	4x EH 5030/MH-FLEX/ 6,5x 875/1275/230 2x EH 5030/MH-FLEX/ 6,5x 450/750/230											
15.5															
384	> 143.75 - 156.25	40	230V / 6800 W	4x EH 5030/MH-FLEX/ 6,5x 925/1325/230 2x EH 5030/MH-FLEX/ 6,5x 450/750/230											
0															
409	> 156.25 - 168.75	15.5	230V / 7000 W	4x EH 5030/MH-FLEX/ 6,5x 975/1375/230 2x EH 5030/MH-FLEX/ 6,5x 450/750/230											
40															
434	> 168.75 - 181.25	0	230V / 7200 W	4x EH 5030/MH-FLEX/ 6,5x 1025/1425/230 2x EH 5030/MH-FLEX/ 6,5x 450/750/230											
15.5															
459	> 181.25 - 193.75	40													
484	> 193.75 - 206.25	15.5													
		40													

2) CP: Control points of hot runner manifold

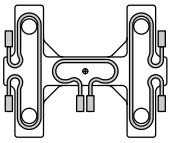
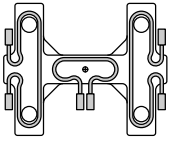
Item	L	B	I1 (min.-max.)	I2 (min.-max.)	d1	d2	d3	S (min.-max.)	T (min.-max.)	R	CP ²⁾	Power total watts	Manifold heater item no.	d	Type
EH 6000/ HMT4	159	= 2 x I1 + 100	> 147,5 - 160	25 - 43.75	6	5	6	86 - 116	15 - 160	0	3	230V / 4100 W	4x EH 5030/MH-FLEX/ 6,5x 375/600/230 2x EH 5030/MH-FLEX/ 6,5x 500/850/230	19	
	184			> 43.75 - 56.25						15.5					
	209			> 56.25 - 68.75						40		0			
	234			> 68.75 - 81.25						15.5		0			
	259			> 81.25 - 93.75						40		0			
	284			> 93.75 - 106.25						15.5		0			
	309			> 106.25 - 118.75						40		0			
	334			> 118.75 - 131.25						15.5		0			
	359			> 131.25 - 143.75						40		0			
	384			> 143.75 - 156.25						15.5		0			
	409			> 156.25 - 168.75						40		0			
	434			> 168.75 - 181.25						15.5		0			
	459			> 181.25 - 193.75						40		0			
	484			> 193.75 - 206.25						15.5		0			
	230V / 4500 W			4x EH 5030/MH-FLEX/ 6,5x 425/700/230 2x EH 5030/MH-FLEX/ 6,5x 500/850/230											
	230V / 4900 W			4x EH 5030/MH-FLEX/ 6,5x 475/800/230 2x EH 5030/MH-FLEX/ 6,5x 500/850/230											
230V / 5300 W	4x EH 5030/MH-FLEX/ 6,5x 525/900/230 2x EH 5030/MH-FLEX/ 6,5x 500/850/230														
230V / 5600 W	4x EH 5030/MH-FLEX/ 6,5x 575/975/230 2x EH 5030/MH-FLEX/ 6,5x 500/850/230														
230V / 5800 W	4x EH 5030/MH-FLEX/ 6,5x 625/1025/230 2x EH 5030/MH-FLEX/ 6,5x 500/850/230														
230V / 6000 W	4x EH 5030/MH-FLEX/ 6,5x 675/1075/230 2x EH 5030/MH-FLEX/ 6,5x 500/850/230														
230V / 6200 W	4x EH 5030/MH-FLEX/ 6,5x 725/1125/230 2x EH 5030/MH-FLEX/ 6,5x 500/850/230														
230V / 6400 W	4x EH 5030/MH-FLEX/ 6,5x 775/1175/230 2x EH 5030/MH-FLEX/ 6,5x 500/850/230														
230V / 6600 W	4x EH 5030/MH-FLEX/ 6,5x 825/1225/230 2x EH 5030/MH-FLEX/ 6,5x 500/850/230														
230V / 6800 W	4x EH 5030/MH-FLEX/ 6,5x 875/1275/230 2x EH 5030/MH-FLEX/ 6,5x 500/850/230														
230V / 7000 W	4x EH 5030/MH-FLEX/ 6,5x 925/1325/230 2x EH 5030/MH-FLEX/ 6,5x 500/850/230														
230V / 7200 W	4x EH 5030/MH-FLEX/ 6,5x 975/1375/230 2x EH 5030/MH-FLEX/ 6,5x 500/850/230														
230V / 7400 W	4x EH 5030/MH-FLEX/ 6,5x 1025/1425/230 2x EH 5030/MH-FLEX/ 6,5x 500/850/230														
EH 6000/ HMT4	159	= 2 x I1 + 100	> 160 - 172,5	25 - 43.75	6	5	6	86 - 116	15 - 160	0	3	230V / 4300 W	4x EH 5030/MH-FLEX/ 6,5x 375/600/230 2x EH 5030/MH-FLEX/ 6,5x 550/950/230	19	
	184			> 43.75 - 56.25						15.5					
	209			> 56.25 - 68.75						40		0			
	234			> 68.75 - 81.25						15.5		0			
	259			> 81.25 - 93.75						40		0			
	284			> 93.75 - 106.25						15.5		0			
	309			> 106.25 - 118.75						40		0			
	230V / 4700 W			4x EH 5030/MH-FLEX/ 6,5x 425/700/230 2x EH 5030/MH-FLEX/ 6,5x 550/950/230											
230V / 5100 W	4x EH 5030/MH-FLEX/ 6,5x 475/800/230 2x EH 5030/MH-FLEX/ 6,5x 550/950/230														
230V / 5500 W	4x EH 5030/MH-FLEX/ 6,5x 525/900/230 2x EH 5030/MH-FLEX/ 6,5x 550/950/230														
230V / 5800 W	4x EH 5030/MH-FLEX/ 6,5x 575/975/230 2x EH 5030/MH-FLEX/ 6,5x 550/950/230														
230V / 6000 W	4x EH 5030/MH-FLEX/ 6,5x 625/1025/230 2x EH 5030/MH-FLEX/ 6,5x 550/950/230														
230V / 6200 W	4x EH 5030/MH-FLEX/ 6,5x 675/1075/230 2x EH 5030/MH-FLEX/ 6,5x 550/950/230														

2) CP: Control points of hot runner manifold

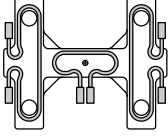
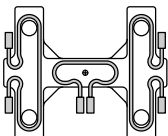
Item	L	B	I1 (min.-max.)	I2 (min.-max.)	d1	d2	d3	S (min.-max.)	T (min.-max.)	R	CP ²⁾	Power total watts	Manifold heater item no.	d	Type
EH 6000/ HMT4	334	= 2 x I1 + 100	> 160 - 172,5	> 118.75 - 131.25	6	5	6	86 - 116	15 - 160	0	3	230V / 6400 W	4x EH 5030/MH-FLEX/ 6,5x 725/1125/230 2x EH 5030/MH-FLEX/ 6,5x 550/950/230	19	
	15.5														
	40			230V / 6600 W						4x EH 5030/MH-FLEX/ 6,5x 775/1175/230 2x EH 5030/MH-FLEX/ 6,5x 550/950/230					
	0														
	15.5			230V / 6800 W						4x EH 5030/MH-FLEX/ 6,5x 825/1225/230 2x EH 5030/MH-FLEX/ 6,5x 550/950/230					
	40														
	0			230V / 7000 W						4x EH 5030/MH-FLEX/ 6,5x 875/1275/230 2x EH 5030/MH-FLEX/ 6,5x 550/950/230					
	15.5														
40	230V / 7200 W	4x EH 5030/MH-FLEX/ 6,5x 925/1325/230 2x EH 5030/MH-FLEX/ 6,5x 550/950/230													
0															
15.5	230V / 7400 W	4x EH 5030/MH-FLEX/ 6,5x 975/1375/230 2x EH 5030/MH-FLEX/ 6,5x 550/950/230													
40															
0	230V / 7600 W	4x EH 5030/MH-FLEX/ 6,5x 1025/1425/230 2x EH 5030/MH-FLEX/ 6,5x 550/950/230													
15.5															
40															
EH 6000/ HMT4	159	= 2 x I1 + 100	> 172,5 - 185	25 - 43.75	6	5	6	86 - 116	15 - 160	0	3	230V / 4400 W	4x EH 5030/MH-FLEX/ 6,5x 375/600/230 2x EH 5030/MH-FLEX/ 6,5x 600/1000/230	19	
	15.5														
	40			230V / 4800 W						4x EH 5030/MH-FLEX/ 6,5x 425/700/230 2x EH 5030/MH-FLEX/ 6,5x 600/1000/230					
	0														
	15.5			230V / 5200 W						4x EH 5030/MH-FLEX/ 6,5x 475/800/230 2x EH 5030/MH-FLEX/ 6,5x 600/1000/230					
	40														
	0			230V / 5600 W						4x EH 5030/MH-FLEX/ 6,5x 525/900/230 2x EH 5030/MH-FLEX/ 6,5x 600/1000/230					
	15.5														
	40			230V / 5900 W						4x EH 5030/MH-FLEX/ 6,5x 575/975/230 2x EH 5030/MH-FLEX/ 6,5x 600/1000/230					
	0														
	15.5			230V / 6100 W						4x EH 5030/MH-FLEX/ 6,5x 625/1025/230 2x EH 5030/MH-FLEX/ 6,5x 600/1000/230					
	40														
	0			230V / 6300 W						4x EH 5030/MH-FLEX/ 6,5x 675/1075/230 2x EH 5030/MH-FLEX/ 6,5x 600/1000/230					
	15.5														
	40			230V / 6500 W						4x EH 5030/MH-FLEX/ 6,5x 725/1125/230 2x EH 5030/MH-FLEX/ 6,5x 600/1000/230					
	0														
15.5	230V / 6700 W	4x EH 5030/MH-FLEX/ 6,5x 775/1175/230 2x EH 5030/MH-FLEX/ 6,5x 600/1000/230													
40															
0	230V / 6900 W	4x EH 5030/MH-FLEX/ 6,5x 825/1225/230 2x EH 5030/MH-FLEX/ 6,5x 600/1000/230													
15.5															
40	230V / 7100 W	4x EH 5030/MH-FLEX/ 6,5x 875/1275/230 2x EH 5030/MH-FLEX/ 6,5x 600/1000/230													
0															
15.5	230V / 7300 W	4x EH 5030/MH-FLEX/ 6,5x 925/1325/230 2x EH 5030/MH-FLEX/ 6,5x 600/1000/230													
40															
0	230V / 7500 W	4x EH 5030/MH-FLEX/ 6,5x 975/1375/230 2x EH 5030/MH-FLEX/ 6,5x 600/1000/230													
15.5															
40	230V / 7700 W	4x EH 5030/MH-FLEX/ 6,5x 1025/1425/230 2x EH 5030/MH-FLEX/ 6,5x 600/1000/230													
0															
15.5															
40															

2) CP: Control points of hot runner manifold

Item	L	B	I1 (min.-max.)	I2 (min.-max.)	d1	d2	d3	S (min.-max.)	T (min.-max.)	R	CP ²⁾	Power total watts	Manifold heater item no.	d	Type
EH 6000/ HMT4	159	= 2 x I1 + 100	> 185 - 197,5	25 - 43.75	6	5	6	86 - 116	15 - 160	0	3	230V / 4500 W	4x EH 5030/MH-FLEX/ 6,5x 375/600/230 2x EH 5030/MH-FLEX/ 6,5x 650/1050/230	19	
				15.5											
				40											
	184			> 43.75 - 56.25						0		230V / 4900 W	4x EH 5030/MH-FLEX/ 6,5x 425/700/230 2x EH 5030/MH-FLEX/ 6,5x 650/1050/230		
				15.5											
				40											
	209			> 56.25 - 68.75						0		230V / 5300 W	4x EH 5030/MH-FLEX/ 6,5x 475/800/230 2x EH 5030/MH-FLEX/ 6,5x 650/1050/230		
				15.5											
				40											
	234			> 68.75 - 81.25						0		230V / 5700 W	4x EH 5030/MH-FLEX/ 6,5x 525/900/230 2x EH 5030/MH-FLEX/ 6,5x 650/1050/230		
				15.5											
				40											
	259			> 81.25 - 93.75						0		230V / 6000 W	4x EH 5030/MH-FLEX/ 6,5x 575/975/230 2x EH 5030/MH-FLEX/ 6,5x 650/1050/230		
				15.5											
				40											
	284			> 93.75 - 106.25						0		230V / 6200 W	4x EH 5030/MH-FLEX/ 6,5x 625/1025/230 2x EH 5030/MH-FLEX/ 6,5x 650/1050/230		
	15.5														
	40														
309	> 106.25 - 118.75	0	230V / 6400 W	4x EH 5030/MH-FLEX/ 6,5x 675/1075/230 2x EH 5030/MH-FLEX/ 6,5x 650/1050/230											
	15.5														
	40														
334	> 118.75 - 131.25	0	230V / 6600 W	4x EH 5030/MH-FLEX/ 6,5x 725/1125/230 2x EH 5030/MH-FLEX/ 6,5x 650/1050/230											
	15.5														
	40														
359	> 131.25 - 143.75	0	230V / 6800 W	4x EH 5030/MH-FLEX/ 6,5x 775/1175/230 2x EH 5030/MH-FLEX/ 6,5x 650/1050/230											
	15.5														
	40														
384	> 143.75 - 156.25	0	230V / 7000 W	4x EH 5030/MH-FLEX/ 6,5x 825/1225/230 2x EH 5030/MH-FLEX/ 6,5x 650/1050/230											
	15.5														
	40														
409	> 156.25 - 168.75	0	230V / 7200 W	4x EH 5030/MH-FLEX/ 6,5x 875/1275/230 2x EH 5030/MH-FLEX/ 6,5x 650/1050/230											
	15.5														
	40														
434	> 168.75 - 181.25	0	230V / 7400 W	4x EH 5030/MH-FLEX/ 6,5x 925/1325/230 2x EH 5030/MH-FLEX/ 6,5x 650/1050/230											
	15.5														
	40														
459	> 181.25 - 193.75	0	230V / 7600 W	4x EH 5030/MH-FLEX/ 6,5x 975/1375/230 2x EH 5030/MH-FLEX/ 6,5x 650/1050/230											
	15.5														
	40														
484	> 193.75 - 206.25	0	230V / 7800 W	4x EH 5030/MH-FLEX/ 6,5x 1025/1425/230 2x EH 5030/MH-FLEX/ 6,5x 650/1050/230											
	15.5														
	40														
EH 6000/ HMT4	159	= 2 x I1 + 100	> 197,5 - 210	25 - 43.75	6	5	6	86 - 116	15 - 160	0	3	230V / 4600 W	4x EH 5030/MH-FLEX/ 6,5x 375/600/230 2x EH 5030/MH-FLEX/ 6,5x 700/1100/230	19	
				15.5											
				40											
	184			> 43.75 - 56.25						0		230V / 5000 W	4x EH 5030/MH-FLEX/ 6,5x 425/700/230 2x EH 5030/MH-FLEX/ 6,5x 700/1100/230		
				15.5											
				40											
	209			> 56.25 - 68.75						0		230V / 5400 W	4x EH 5030/MH-FLEX/ 6,5x 475/800/230 2x EH 5030/MH-FLEX/ 6,5x 700/1100/230		
				15.5											
	40														
234	> 68.75 - 81.25	0	230V / 5800 W	4x EH 5030/MH-FLEX/ 6,5x 525/900/230 2x EH 5030/MH-FLEX/ 6,5x 700/1100/230											
	15.5														
	40														
259	> 81.25 - 93.75	0	230V / 6100 W	4x EH 5030/MH-FLEX/ 6,5x 575/975/230 2x EH 5030/MH-FLEX/ 6,5x 700/1100/230											
	15.5														
	40														
284	> 93.75 - 106.25	0	230V / 6300 W	4x EH 5030/MH-FLEX/ 6,5x 625/1025/230 2x EH 5030/MH-FLEX/ 6,5x 700/1100/230											
	15.5														
	40														
309	> 106.25 - 118.75	0	230V / 6500 W	4x EH 5030/MH-FLEX/ 6,5x 675/1075/230 2x EH 5030/MH-FLEX/ 6,5x 700/1100/230											
	15.5														
	40														

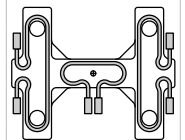
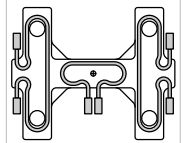

2) CP: Control points of hot runner manifold

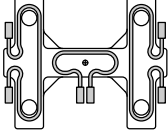
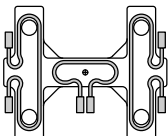
Item	L	B	I1 (min.-max.)	I2 (min.-max.)	d1	d2	d3	S (min.-max.)	T (min.-max.)	R	CP ²⁾	Power total watts	Manifold heater item no.	d	Type
EH 6000/ HMT4	334	= 2 x I1 + 100	> 197,5 - 210	> 118.75 - 131.25	6	5	6	86 - 116	15 - 160	0	3	230V / 6700 W	4x EH 5030/MH-FLEX/ 6,5x 725/1125/230 2x EH 5030/MH-FLEX/ 6,5x 700/1100/230	19	
	15.5														
	40			230V / 6900 W						4x EH 5030/MH-FLEX/ 6,5x 775/1175/230 2x EH 5030/MH-FLEX/ 6,5x 700/1100/230					
	0														
	15.5			230V / 7100 W						4x EH 5030/MH-FLEX/ 6,5x 825/1225/230 2x EH 5030/MH-FLEX/ 6,5x 700/1100/230					
	40														
	359			> 131.25 - 143.75						0		230V / 7300 W	4x EH 5030/MH-FLEX/ 6,5x 875/1275/230 2x EH 5030/MH-FLEX/ 6,5x 700/1100/230		
	15.5														
384	> 143.75 - 156.25	0	230V / 7500 W	4x EH 5030/MH-FLEX/ 6,5x 925/1325/230 2x EH 5030/MH-FLEX/ 6,5x 700/1100/230											
15.5															
409	> 156.25 - 168.75	0	230V / 7700 W	4x EH 5030/MH-FLEX/ 6,5x 975/1375/230 2x EH 5030/MH-FLEX/ 6,5x 700/1100/230											
15.5															
434	> 168.75 - 181.25	0	230V / 7900 W	4x EH 5030/MH-FLEX/ 6,5x 1025/1425/230 2x EH 5030/MH-FLEX/ 6,5x 700/1100/230											
15.5															
459	> 181.25 - 193.75	0	230V / 3400 W	4x EH 5030/MH-FLEX/ 6,5x 375/600/230 2x EH 5030/MH-FLEX/ 6,5x 325/500/230											
15.5															
484	> 193.75 - 206.25	0	230V / 3800 W	4x EH 5030/MH-FLEX/ 6,5x 425/700/230 2x EH 5030/MH-FLEX/ 6,5x 325/500/230											
15.5															
EH 6000/ HMT4	159	= 2 x I1 + 100	> 110 - 122,5	25 - 43.75	8	8	10	86 - 116	15 - 160	0	3	230V / 4200 W	4x EH 5030/MH-FLEX/ 6,5x 475/800/230 2x EH 5030/MH-FLEX/ 6,5x 325/500/230	27	
	15.5														
	184			> 43.75 - 56.25						0		230V / 4600 W	4x EH 5030/MH-FLEX/ 6,5x 525/900/230 2x EH 5030/MH-FLEX/ 6,5x 325/500/230		
	15.5														
	209			> 56.25 - 68.75						0		230V / 4900 W	4x EH 5030/MH-FLEX/ 6,5x 575/975/230 2x EH 5030/MH-FLEX/ 6,5x 325/500/230		
	15.5														
	234			> 68.75 - 81.25						0		230V / 5100 W	4x EH 5030/MH-FLEX/ 6,5x 625/1025/230 2x EH 5030/MH-FLEX/ 6,5x 325/500/230		
	15.5														
	259			> 81.25 - 93.75						0		230V / 5300 W	4x EH 5030/MH-FLEX/ 6,5x 675/1075/230 2x EH 5030/MH-FLEX/ 6,5x 325/500/230		
	15.5														
	284			> 93.75 - 106.25						0		230V / 5500 W	4x EH 5030/MH-FLEX/ 6,5x 725/1125/230 2x EH 5030/MH-FLEX/ 6,5x 325/500/230		
	15.5														
	309			> 106.25 - 118.75						0		230V / 5700 W	4x EH 5030/MH-FLEX/ 6,5x 775/1175/230 2x EH 5030/MH-FLEX/ 6,5x 325/500/230		
	15.5														
	334			> 118.75 - 131.25						0		230V / 5900 W	4x EH 5030/MH-FLEX/ 6,5x 825/1225/230 2x EH 5030/MH-FLEX/ 6,5x 325/500/230		
	15.5														
359	> 131.25 - 143.75	0	230V / 6100 W	4x EH 5030/MH-FLEX/ 6,5x 875/1275/230 2x EH 5030/MH-FLEX/ 6,5x 325/500/230											
15.5															
384	> 143.75 - 156.25	0	230V / 6300 W	4x EH 5030/MH-FLEX/ 6,5x 925/1325/230 2x EH 5030/MH-FLEX/ 6,5x 325/500/230											
15.5															
409	> 156.25 - 168.75	0	230V / 6500 W	4x EH 5030/MH-FLEX/ 6,5x 975/1375/230 2x EH 5030/MH-FLEX/ 6,5x 325/500/230											
15.5															
434	> 168.75 - 181.25	0	230V / 6700 W	4x EH 5030/MH-FLEX/ 6,5x 1025/1425/230 2x EH 5030/MH-FLEX/ 6,5x 325/500/230											
15.5															
459	> 181.25 - 193.75	0	230V / 6900 W	4x EH 5030/MH-FLEX/ 6,5x 1075/1475/230 2x EH 5030/MH-FLEX/ 6,5x 325/500/230											
15.5															
484	> 193.75 - 206.25	0	230V / 7100 W	4x EH 5030/MH-FLEX/ 6,5x 1125/1525/230 2x EH 5030/MH-FLEX/ 6,5x 325/500/230											
15.5															
409	> 156.25 - 168.75	0	230V / 7300 W	4x EH 5030/MH-FLEX/ 6,5x 1175/1575/230 2x EH 5030/MH-FLEX/ 6,5x 325/500/230											
15.5															
434	> 168.75 - 181.25	0	230V / 7500 W	4x EH 5030/MH-FLEX/ 6,5x 1225/1625/230 2x EH 5030/MH-FLEX/ 6,5x 325/500/230											
15.5															
459	> 181.25 - 193.75	0	230V / 7700 W	4x EH 5030/MH-FLEX/ 6,5x 1275/1675/230 2x EH 5030/MH-FLEX/ 6,5x 325/500/230											
15.5															
484	> 193.75 - 206.25	0	230V / 7900 W	4x EH 5030/MH-FLEX/ 6,5x 1325/1725/230 2x EH 5030/MH-FLEX/ 6,5x 325/500/230											
15.5															

2) CP: Control points of hot runner manifold

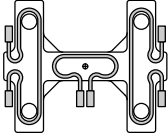
Item	L	B	I1 (min.-max.)	I2 (min.-max.)	d1	d2	d3	S (min.-max.)	T (min.-max.)	R	CP ²⁾	Power total watts	Manifold heater item no.	d	Type											
EH 6000/ HMT4	159	= 2 x I1 + 100	> 122,5 - 135	25 - 43.75	8	8	10	86 - 116	15 - 160	0	3	230V / 3600 W	4x EH 5030/MH-FLEX/ 6,5x 375/600/230 2x EH 5030/MH-FLEX/ 6,5x 375/600/230	27												
	184			> 43.75 - 56.25						15.5						0	230V / 4000 W	4x EH 5030/MH-FLEX/ 6,5x 425/700/230 2x EH 5030/MH-FLEX/ 6,5x 375/600/230								
	209			> 56.25 - 68.75						40		0	230V / 4400 W			4x EH 5030/MH-FLEX/ 6,5x 475/800/230 2x EH 5030/MH-FLEX/ 6,5x 375/600/230										
	234			> 68.75 - 81.25						15.5		0					230V / 4800 W	4x EH 5030/MH-FLEX/ 6,5x 525/900/230 2x EH 5030/MH-FLEX/ 6,5x 375/600/230								
	259			> 81.25 - 93.75						40		0	230V / 5100 W			4x EH 5030/MH-FLEX/ 6,5x 575/975/230 2x EH 5030/MH-FLEX/ 6,5x 375/600/230										
	284			> 93.75 - 106.25						15.5		0					230V / 5300 W	4x EH 5030/MH-FLEX/ 6,5x 625/1025/230 2x EH 5030/MH-FLEX/ 6,5x 375/600/230								
	309			> 106.25 - 118.75						40		0	230V / 5500 W			4x EH 5030/MH-FLEX/ 6,5x 675/1075/230 2x EH 5030/MH-FLEX/ 6,5x 375/600/230										
	334			> 118.75 - 131.25						15.5		0					230V / 5700 W	4x EH 5030/MH-FLEX/ 6,5x 725/1125/230 2x EH 5030/MH-FLEX/ 6,5x 375/600/230								
	359			> 131.25 - 143.75						40		0	230V / 5900 W			4x EH 5030/MH-FLEX/ 6,5x 775/1175/230 2x EH 5030/MH-FLEX/ 6,5x 375/600/230										
	384			> 143.75 - 156.25						15.5		0					230V / 6100 W	4x EH 5030/MH-FLEX/ 6,5x 825/1225/230 2x EH 5030/MH-FLEX/ 6,5x 375/600/230								
	409			> 156.25 - 168.75						40		0	230V / 6300 W			4x EH 5030/MH-FLEX/ 6,5x 875/1275/230 2x EH 5030/MH-FLEX/ 6,5x 375/600/230										
	434			> 168.75 - 181.25						15.5		0					230V / 6500 W	4x EH 5030/MH-FLEX/ 6,5x 925/1325/230 2x EH 5030/MH-FLEX/ 6,5x 375/600/230								
	459			> 181.25 - 193.75						40		0	230V / 6700 W			4x EH 5030/MH-FLEX/ 6,5x 975/1375/230 2x EH 5030/MH-FLEX/ 6,5x 375/600/230										
	484			> 193.75 - 206.25						15.5		0					230V / 6900 W	4x EH 5030/MH-FLEX/ 6,5x 1025/1425/230 2x EH 5030/MH-FLEX/ 6,5x 375/600/230								
	EH 6000/ HMT4			159						= 2 x I1 + 100		> 135 - 147,5	25 - 43.75			8			8	10	86 - 116	15 - 160	0	3	230V / 3800 W	4x EH 5030/MH-FLEX/ 6,5x 375/600/230 2x EH 5030/MH-FLEX/ 6,5x 425/700/230
	184			> 43.75 - 56.25									15.5				0	230V / 4200 W					4x EH 5030/MH-FLEX/ 6,5x 425/700/230 2x EH 5030/MH-FLEX/ 6,5x 425/700/230			
209	> 56.25 - 68.75	40	0	230V / 4600 W	4x EH 5030/MH-FLEX/ 6,5x 475/800/230 2x EH 5030/MH-FLEX/ 6,5x 425/700/230																					
234	> 68.75 - 81.25	15.5	0			230V / 5000 W	4x EH 5030/MH-FLEX/ 6,5x 525/900/230 2x EH 5030/MH-FLEX/ 6,5x 425/700/230																			
259	> 81.25 - 93.75	40	0	230V / 5300 W	4x EH 5030/MH-FLEX/ 6,5x 575/975/230 2x EH 5030/MH-FLEX/ 6,5x 425/700/230																					
284	> 93.75 - 106.25	15.5	0			230V / 5500 W	4x EH 5030/MH-FLEX/ 6,5x 625/1025/230 2x EH 5030/MH-FLEX/ 6,5x 425/700/230																			
309	> 106.25 - 118.75	40	0	230V / 5700 W	4x EH 5030/MH-FLEX/ 6,5x 675/1075/230 2x EH 5030/MH-FLEX/ 6,5x 425/700/230																					
		15.5	0			230V / 5900 W	4x EH 5030/MH-FLEX/ 6,5x 725/1125/230 2x EH 5030/MH-FLEX/ 6,5x 425/700/230																			
		40	0	230V / 6100 W	4x EH 5030/MH-FLEX/ 6,5x 775/1175/230 2x EH 5030/MH-FLEX/ 6,5x 425/700/230																					
		15.5	0			230V / 6300 W	4x EH 5030/MH-FLEX/ 6,5x 825/1225/230 2x EH 5030/MH-FLEX/ 6,5x 425/700/230																			
		40	0	230V / 6500 W	4x EH 5030/MH-FLEX/ 6,5x 875/1275/230 2x EH 5030/MH-FLEX/ 6,5x 425/700/230																					
		15.5	0			230V / 6700 W	4x EH 5030/MH-FLEX/ 6,5x 925/1325/230 2x EH 5030/MH-FLEX/ 6,5x 425/700/230																			
		40	0	230V / 6900 W	4x EH 5030/MH-FLEX/ 6,5x 975/1375/230 2x EH 5030/MH-FLEX/ 6,5x 425/700/230																					
		15.5	0			230V / 7100 W	4x EH 5030/MH-FLEX/ 6,5x 1025/1425/230 2x EH 5030/MH-FLEX/ 6,5x 425/700/230																			
		40	0	230V / 7300 W	4x EH 5030/MH-FLEX/ 6,5x 1075/1475/230 2x EH 5030/MH-FLEX/ 6,5x 425/700/230																					

2) CP: Control points of hot runner manifold

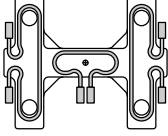
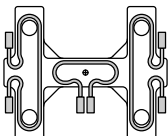
Item	L	B	I1 (min.-max.)	I2 (min.-max.)	d1	d2	d3	S (min.-max.)	T (min.-max.)	R	CP ²⁾	Power total watts	Manifold heater item no.	d	Type	
EH 6000/ HMT4	334	= 2 x I1 + 100	> 133 - 147,5/135	> 118.75 - 131.25	8	8	10	86 - 116	15 - 160	0	3	230V / 5900 W	4x EH 5030/MH-FLEX/ 6,5x 725/1125/230 2x EH 5030/MH-FLEX/ 6,5x 425/700/230	27		
	15.5															
	359									0		230V / 6100 W	4x EH 5030/MH-FLEX/ 6,5x 775/1175/230 2x EH 5030/MH-FLEX/ 6,5x 425/700/230			15.5
	40															
	384									0		230V / 6300 W	4x EH 5030/MH-FLEX/ 6,5x 825/1225/230 2x EH 5030/MH-FLEX/ 6,5x 425/700/230			15.5
	40															
	409									0		230V / 6500 W	4x EH 5030/MH-FLEX/ 6,5x 875/1275/230 2x EH 5030/MH-FLEX/ 6,5x 425/700/230			15.5
	40															
434	0	230V / 6700 W	4x EH 5030/MH-FLEX/ 6,5x 925/1325/230 2x EH 5030/MH-FLEX/ 6,5x 425/700/230	15.5												
40																
459	0	230V / 6900 W	4x EH 5030/MH-FLEX/ 6,5x 975/1375/230 2x EH 5030/MH-FLEX/ 6,5x 425/700/230	15.5												
40																
484	0	230V / 7100 W	4x EH 5030/MH-FLEX/ 6,5x 1025/1425/230 2x EH 5030/MH-FLEX/ 6,5x 425/700/230	15.5												
40																
EH 6000/ HMT4	159	= 2 x I1 + 100	> 147,5 - 160	25 - 43.75	8	8	10	86 - 116	15 - 160	0	3	230V / 4000 W	4x EH 5030/MH-FLEX/ 6,5x 375/600/230 2x EH 5030/MH-FLEX/ 6,5x 475/800/230	27		
	15.5															
	184									0		230V / 4400 W	4x EH 5030/MH-FLEX/ 6,5x 425/700/230 2x EH 5030/MH-FLEX/ 6,5x 475/800/230			15.5
	40															
	209									0		230V / 4800 W	4x EH 5030/MH-FLEX/ 6,5x 475/800/230 2x EH 5030/MH-FLEX/ 6,5x 475/800/230			15.5
	40															
	234									0		230V / 5200 W	4x EH 5030/MH-FLEX/ 6,5x 525/900/230 2x EH 5030/MH-FLEX/ 6,5x 475/800/230			15.5
	40															
	259									0		230V / 5500 W	4x EH 5030/MH-FLEX/ 6,5x 575/975/230 2x EH 5030/MH-FLEX/ 6,5x 475/800/230			15.5
	40															
	284									0		230V / 5700 W	4x EH 5030/MH-FLEX/ 6,5x 625/1025/230 2x EH 5030/MH-FLEX/ 6,5x 475/800/230			15.5
	40															
	309									0		230V / 5900 W	4x EH 5030/MH-FLEX/ 6,5x 675/1075/230 2x EH 5030/MH-FLEX/ 6,5x 475/800/230			15.5
	40															
	334									0		230V / 6100 W	4x EH 5030/MH-FLEX/ 6,5x 725/1125/230 2x EH 5030/MH-FLEX/ 6,5x 475/800/230			15.5
	40															
359	0	230V / 6300 W	4x EH 5030/MH-FLEX/ 6,5x 775/1175/230 2x EH 5030/MH-FLEX/ 6,5x 475/800/230	15.5												
40																
384	0	230V / 6500 W	4x EH 5030/MH-FLEX/ 6,5x 825/1225/230 2x EH 5030/MH-FLEX/ 6,5x 475/800/230	15.5												
40																
409	0	230V / 6700 W	4x EH 5030/MH-FLEX/ 6,5x 875/1275/230 2x EH 5030/MH-FLEX/ 6,5x 475/800/230	15.5												
40																
434	0	230V / 6900 W	4x EH 5030/MH-FLEX/ 6,5x 925/1325/230 2x EH 5030/MH-FLEX/ 6,5x 475/800/230	15.5												
40																
459	0	230V / 7100 W	4x EH 5030/MH-FLEX/ 6,5x 975/1375/230 2x EH 5030/MH-FLEX/ 6,5x 475/800/230	15.5												
40																
484	0	230V / 7300 W	4x EH 5030/MH-FLEX/ 6,5x 1025/1425/230 2x EH 5030/MH-FLEX/ 6,5x 475/800/230	15.5												
40																

2) CP: Control points of hot runner manifold

Item	L	B	I1 (min.-max.)	I2 (min.-max.)	d1	d2	d3	S (min.-max.)	T (min.-max.)	R	CP ²⁾	Power total watts	Manifold heater item no.	d	Type
EH 6000/ HMT4	159	= 2 x I1 + 100	> 160 - 172,5	25 - 43.75	8	8	10	86 - 116	15 - 160	0	3	230V / 4200 W	4x EH 5030/MH-FLEX/ 6,5x 375/600/230 2x EH 5030/MH-FLEX/ 6,5x 525/900/230	27	
	15.5														
	40														
	0			230V / 4600 W						4x EH 5030/MH-FLEX/ 6,5x 425/700/230 2x EH 5030/MH-FLEX/ 6,5x 525/900/230					
	15.5														
	40														
	0			230V / 5000 W						4x EH 5030/MH-FLEX/ 6,5x 475/800/230 2x EH 5030/MH-FLEX/ 6,5x 525/900/230					
	15.5														
	40														
	0			230V / 5400 W						4x EH 5030/MH-FLEX/ 6,5x 525/900/230 2x EH 5030/MH-FLEX/ 6,5x 525/900/230					
	15.5														
	40														
	0			230V / 5700 W						4x EH 5030/MH-FLEX/ 6,5x 575/975/230 2x EH 5030/MH-FLEX/ 6,5x 525/900/230					
	15.5														
	40														
	0			230V / 5900 W						4x EH 5030/MH-FLEX/ 6,5x 625/1025/230 2x EH 5030/MH-FLEX/ 6,5x 525/900/230					
15.5															
40															
0	230V / 6100 W	4x EH 5030/MH-FLEX/ 6,5x 675/1075/230 2x EH 5030/MH-FLEX/ 6,5x 525/900/230													
15.5															
40															
0	230V / 6300 W	4x EH 5030/MH-FLEX/ 6,5x 725/1125/230 2x EH 5030/MH-FLEX/ 6,5x 525/900/230													
15.5															
40															
0	230V / 6500 W	4x EH 5030/MH-FLEX/ 6,5x 775/1175/230 2x EH 5030/MH-FLEX/ 6,5x 525/900/230													
15.5															
40															
0	230V / 6700 W	4x EH 5030/MH-FLEX/ 6,5x 825/1225/230 2x EH 5030/MH-FLEX/ 6,5x 525/900/230													
15.5															
40															
0	230V / 6900 W	4x EH 5030/MH-FLEX/ 6,5x 875/1275/230 2x EH 5030/MH-FLEX/ 6,5x 525/900/230													
15.5															
40															
0	230V / 7100 W	4x EH 5030/MH-FLEX/ 6,5x 925/1325/230 2x EH 5030/MH-FLEX/ 6,5x 525/900/230													
15.5															
40															
0	230V / 7300 W	4x EH 5030/MH-FLEX/ 6,5x 975/1375/230 2x EH 5030/MH-FLEX/ 6,5x 525/900/230													
15.5															
40															
0	230V / 7500 W	4x EH 5030/MH-FLEX/ 6,5x 1025/1425/230 2x EH 5030/MH-FLEX/ 6,5x 525/900/230													
15.5															
40															
EH 6000/ HMT4	159	= 2 x I1 + 100	> 172,5 - 185	25 - 43.75	8	8	10	86 - 116	15 - 160	0	3	230V / 4350 W	4x EH 5030/MH-FLEX/ 6,5x 375/600/230 2x EH 5030/MH-FLEX/ 6,5x 575/975/230	27	
	15.5														
	40														
	0			230V / 4750 W						4x EH 5030/MH-FLEX/ 6,5x 425/700/230 2x EH 5030/MH-FLEX/ 6,5x 575/975/230					
	15.5														
	40														
	0			230V / 5150 W						4x EH 5030/MH-FLEX/ 6,5x 475/800/230 2x EH 5030/MH-FLEX/ 6,5x 575/975/230					
	15.5														
40															
0	230V / 5550 W	4x EH 5030/MH-FLEX/ 6,5x 525/900/230 2x EH 5030/MH-FLEX/ 6,5x 575/975/230													
15.5															
40															
0	230V / 5850 W	4x EH 5030/MH-FLEX/ 6,5x 575/975/230 2x EH 5030/MH-FLEX/ 6,5x 575/975/230													
15.5															
40															
0	230V / 6050 W	4x EH 5030/MH-FLEX/ 6,5x 625/1025/230 2x EH 5030/MH-FLEX/ 6,5x 575/975/230													
15.5															
40															
0	230V / 6250 W	4x EH 5030/MH-FLEX/ 6,5x 675/1075/230 2x EH 5030/MH-FLEX/ 6,5x 575/975/230													
15.5															
40															

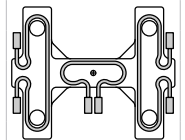
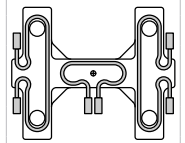

2) CP: Control points of hot runner manifold

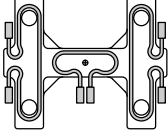
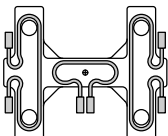
Item	L	B	I1 (min.-max.)	I2 (min.-max.)	d1	d2	d3	S (min.-max.)	T (min.-max.)	R	CP ²⁾	Power total watts	Manifold heater item no.	d	Type	
EH 6000/ HMT4	334	= 2 x I1 + 100	> 172,5 - 185	> 118.75 - 131.25	8	8	10	86 - 116	15 - 160	0	3	230V / 6450 W	4x EH 5030/MH-FLEX/ 6,5x 725/1125/230 2x EH 5030/MH-FLEX/ 6,5x 575/975/230	27		
	15.5			0												
	359			> 131.25 - 143.75						0		15.5	230V / 6650 W			4x EH 5030/MH-FLEX/ 6,5x 775/1175/230 2x EH 5030/MH-FLEX/ 6,5x 575/975/230
	40			0												
	384			> 143.75 - 156.25						0		15.5	230V / 6850 W			4x EH 5030/MH-FLEX/ 6,5x 825/1225/230 2x EH 5030/MH-FLEX/ 6,5x 575/975/230
	40			0												
	409			> 156.25 - 168.75						0		15.5	230V / 7050 W			4x EH 5030/MH-FLEX/ 6,5x 875/1275/230 2x EH 5030/MH-FLEX/ 6,5x 575/975/230
	40			0												
434	> 168.75 - 181.25	0	15.5	230V / 7250 W	4x EH 5030/MH-FLEX/ 6,5x 925/1325/230 2x EH 5030/MH-FLEX/ 6,5x 575/975/230											
40	0															
459	> 181.25 - 193.75	0	15.5	230V / 7450 W	4x EH 5030/MH-FLEX/ 6,5x 975/1375/230 2x EH 5030/MH-FLEX/ 6,5x 575/975/230											
40	0															
484	> 193.75 - 206.25	0	15.5	230V / 7650 W	4x EH 5030/MH-FLEX/ 6,5x 1025/1425/230 2x EH 5030/MH-FLEX/ 6,5x 575/975/230											
40	0															
EH 6000/ HMT4	159	= 2 x I1 + 100	> 185 - 197,5	25 - 43.75	8	8	10	86 - 116	15 - 160	0	3	230V / 4450 W	4x EH 5030/MH-FLEX/ 6,5x 375/600/230 2x EH 5030/MH-FLEX/ 6,5x 625/1025/230	27		
	15.5			0												
	184			> 43.75 - 56.25						0		15.5	230V / 4850 W			4x EH 5030/MH-FLEX/ 6,5x 425/700/230 2x EH 5030/MH-FLEX/ 6,5x 625/1025/230
	40			0												
	209			> 56.25 - 68.75						0		15.5	230V / 5250 W			4x EH 5030/MH-FLEX/ 6,5x 475/800/230 2x EH 5030/MH-FLEX/ 6,5x 625/1025/230
	40			0												
	234			> 68.75 - 81.25						0		15.5	230V / 5650 W			4x EH 5030/MH-FLEX/ 6,5x 525/900/230 2x EH 5030/MH-FLEX/ 6,5x 625/1025/230
	40			0												
	259			> 81.25 - 93.75						0		15.5	230V / 5950 W			4x EH 5030/MH-FLEX/ 6,5x 575/975/230 2x EH 5030/MH-FLEX/ 6,5x 625/1025/230
	40			0												
	284			> 93.75 - 106.25						0		15.5	230V / 6150 W			4x EH 5030/MH-FLEX/ 6,5x 625/1025/230 2x EH 5030/MH-FLEX/ 6,5x 625/1025/230
	40			0												
	309			> 106.25 - 118.75						0		15.5	230V / 6350 W			4x EH 5030/MH-FLEX/ 6,5x 675/1075/230 2x EH 5030/MH-FLEX/ 6,5x 625/1025/230
	40			0												
	334			> 118.75 - 131.25						0		15.5	230V / 6550 W			4x EH 5030/MH-FLEX/ 6,5x 725/1125/230 2x EH 5030/MH-FLEX/ 6,5x 625/1025/230
	40			0												
359	> 131.25 - 143.75	0	15.5	230V / 6750 W	4x EH 5030/MH-FLEX/ 6,5x 775/1175/230 2x EH 5030/MH-FLEX/ 6,5x 625/1025/230											
40	0															
384	> 143.75 - 156.25	0	15.5	230V / 6950 W	4x EH 5030/MH-FLEX/ 6,5x 825/1225/230 2x EH 5030/MH-FLEX/ 6,5x 625/1025/230											
40	0															
409	> 156.25 - 168.75	0	15.5	230V / 7150 W	4x EH 5030/MH-FLEX/ 6,5x 875/1275/230 2x EH 5030/MH-FLEX/ 6,5x 625/1025/230											
40	0															
434	> 168.75 - 181.25	0	15.5	230V / 7350 W	4x EH 5030/MH-FLEX/ 6,5x 925/1325/230 2x EH 5030/MH-FLEX/ 6,5x 625/1025/230											
40	0															
459	> 181.25 - 193.75	0	15.5	230V / 7550 W	4x EH 5030/MH-FLEX/ 6,5x 975/1375/230 2x EH 5030/MH-FLEX/ 6,5x 625/1025/230											
40	0															
484	> 193.75 - 206.25	0	15.5	230V / 7750 W	4x EH 5030/MH-FLEX/ 6,5x 1025/1425/230 2x EH 5030/MH-FLEX/ 6,5x 625/1025/230											
40	0															

2) CP: Control points of hot runner manifold

Item	L	B	I1 (min.-max.)	I2 (min.-max.)	d1	d2	d3	S (min.-max.)	T (min.-max.)	R	CP ²⁾	Power total watts	Manifold heater item no.	d	Type
EH 6000/ HMT4	159	= 2 x 11 + 100	> 197,5 - 210	25 - 43.75	8	8	10	86 - 116	15 - 160	0	3	230V / 4550 W	4x EH 5030/MH-FLEX/ 6,5x 375/600/230 2x EH 5030/MH-FLEX/ 6,5x 675/1075/230	27	
	15.5														
	40														
	0			230V / 4950 W											
	15.5														
	40														
	0			230V / 5350 W											
	15.5														
	40														
	0			230V / 5750 W											
	15.5														
	40														
	0			230V / 6050 W											
	15.5														
	40														
	0			230V / 6250 W											
15.5															
40															
0	230V / 6450 W														
15.5															
40															
0	230V / 6650 W														
15.5															
40															
0	230V / 6850 W														
15.5															
40															
0	230V / 7050 W														
15.5															
40															
0	230V / 7250 W														
15.5															
40															
0	230V / 7450 W														
15.5															
40															
0	230V / 7650 W														
15.5															
40															
0	230V / 7850 W														
15.5															
40															
EH 6000/ HMT4	159	= 2 x 11 + 100	> 110 - 122,5	25 - 43.75	12	12	12	86 - 116	15 - 160	0	3	230V / 3600 W	4x EH 5030/MH-FLEX/ 6,5x 400/650/230 2x EH 5030/MH-FLEX/ 6,5x 325/500/230	37	
	15.5														
	40														
	0			230V / 4000 W											
	15.5														
	40														
	0			230V / 4400 W											
	15.5														
40															
0	230V / 4800 W														
15.5															
40															
0	230V / 5000 W														
15.5															
40															
0	230V / 5200 W														
15.5															
40															
0	230V / 5400 W														
15.5															
40															

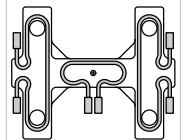
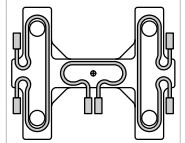

2) CP: Control points of hot runner manifold

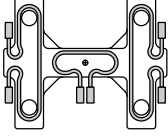
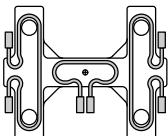
Item	L	B	I1 (min.-max.)	I2 (min.-max.)	d1	d2	d3	S (min.-max.)	T (min.-max.)	R	CP ²⁾	Power total watts	Manifold heater item no.	d	Type												
EH 6000/ HMT4	334	= 2 x I1 + 100	> 110 - 122,5	> 118.75 - 131.25	12	12	12	86 - 116	15 - 160	0	3	230V / 5600 W	4x EH 5030/MH-FLEX/ 6,5x 750/1150/230 2x EH 5030/MH-FLEX/ 6,5x 325/500/230	37													
	15.5																										
	40									230V / 5800 W		4x EH 5030/MH-FLEX/ 6,5x 800/1200/230 2x EH 5030/MH-FLEX/ 6,5x 325/500/230															
	0																										
	359																										
	384																										
	409																										
	434																										
459																											
484																											
EH 6000/ HMT4	159	= 2 x I1 + 100	> 122,5 - 135	37,5 - 43.75	12	12	12	86 - 116	15 - 160	0	3	230V / 3800 W	4x EH 5030/MH-FLEX/ 6,5x 400/650/230 2x EH 5030/MH-FLEX/ 6,5x 375/600/230	37													
	15.5																										
	40									230V / 4200 W		4x EH 5030/MH-FLEX/ 6,5x 450/750/230 2x EH 5030/MH-FLEX/ 6,5x 375/600/230															
	0																										
	184																										
	209																										
	234																										
	259																										
	284																										
	309																										
	334																										
	359																										
	384																										
	409																										
	434																										
	459																										
484																											

2) CP: Control points of hot runner manifold

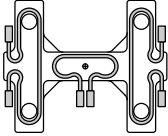
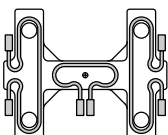
Item	L	B	I1 (min.-max.)	I2 (min.-max.)	d1	d2	d3	S (min.-max.)	T (min.-max.)	R	CP ²⁾	Power total watts	Manifold heater item no.	d	Type
EH 6000/ HMT4	159	= 2 x I1 + 100	> 135 - 147,5	37,5 - 43.75	12	12	12	86 - 116	15 - 160	0	3	230V / 4000 W	4x EH 5030/MH-FLEX/ 6,5x 400/650/230 2x EH 5030/MH-FLEX/ 6,5x 425/700/230	37	
	15.5														
	40														
	0			230V / 4400 W						4x EH 5030/MH-FLEX/ 6,5x 450/750/230 2x EH 5030/MH-FLEX/ 6,5x 425/700/230					
	15.5														
	40														
	0			230V / 4800 W						4x EH 5030/MH-FLEX/ 6,5x 500/850/230 2x EH 5030/MH-FLEX/ 6,5x 425/700/230					
	15.5														
	40														
	0			230V / 5200 W						4x EH 5030/MH-FLEX/ 6,5x 550/950/230 2x EH 5030/MH-FLEX/ 6,5x 425/700/230					
	15.5														
	40														
	0			230V / 5400 W						4x EH 5030/MH-FLEX/ 6,5x 600/1000/230 2x EH 5030/MH-FLEX/ 6,5x 425/700/230					
	15.5														
	40														
	0			230V / 5600 W						4x EH 5030/MH-FLEX/ 6,5x 650/1050/230 2x EH 5030/MH-FLEX/ 6,5x 425/700/230					
15.5															
40															
0	230V / 5800 W	4x EH 5030/MH-FLEX/ 6,5x 700/1100/230 2x EH 5030/MH-FLEX/ 6,5x 425/700/230													
15.5															
40															
0	230V / 6000 W	4x EH 5030/MH-FLEX/ 6,5x 750/1150/230 2x EH 5030/MH-FLEX/ 6,5x 425/700/230													
15.5															
40															
0	230V / 6200 W	4x EH 5030/MH-FLEX/ 6,5x 800/1200/230 2x EH 5030/MH-FLEX/ 6,5x 425/700/230													
15.5															
40															
0	230V / 6400 W	4x EH 5030/MH-FLEX/ 6,5x 850/1250/230 2x EH 5030/MH-FLEX/ 6,5x 425/700/230													
15.5															
40															
0	230V / 6600 W	4x EH 5030/MH-FLEX/ 6,5x 900/1300/230 2x EH 5030/MH-FLEX/ 6,5x 425/700/230													
15.5															
40															
0	230V / 6800 W	4x EH 5030/MH-FLEX/ 6,5x 950/1350/230 2x EH 5030/MH-FLEX/ 6,5x 425/700/230													
15.5															
40															
0	230V / 7000 W	4x EH 5030/MH-FLEX/ 6,5x 1000/1400/230 2x EH 5030/MH-FLEX/ 6,5x 425/700/230													
15.5															
40															
0	230V / 7200 W	4x EH 5030/MH-FLEX/ 6,5x 1050/1450/230 2x EH 5030/MH-FLEX/ 6,5x 425/700/230													
15.5															
40															
EH 6000/ HMT4	159	= 2 x I1 + 100	> 147,5 - 160	37,5 - 43.75	12	12	12	86 - 116	15 - 160	0	3	230V / 4200 W	4x EH 5030/MH-FLEX/ 6,5x 400/650/230 2x EH 5030/MH-FLEX/ 6,5x 475/800/230	37	
	15.5														
	40														
	0			230V / 4600 W						4x EH 5030/MH-FLEX/ 6,5x 450/750/230 2x EH 5030/MH-FLEX/ 6,5x 475/800/230					
	15.5														
	40														
	0			230V / 5000 W						4x EH 5030/MH-FLEX/ 6,5x 500/850/230 2x EH 5030/MH-FLEX/ 6,5x 475/800/230					
	15.5														
40															
0	230V / 5400 W	4x EH 5030/MH-FLEX/ 6,5x 550/950/230 2x EH 5030/MH-FLEX/ 6,5x 475/800/230													
15.5															
40															
0	230V / 5600 W	4x EH 5030/MH-FLEX/ 6,5x 600/1000/230 2x EH 5030/MH-FLEX/ 6,5x 475/800/230													
15.5															
40															
0	230V / 5800 W	4x EH 5030/MH-FLEX/ 6,5x 650/1050/230 2x EH 5030/MH-FLEX/ 6,5x 475/800/230													
15.5															
40															
0	230V / 6000 W	4x EH 5030/MH-FLEX/ 6,5x 700/1100/230 2x EH 5030/MH-FLEX/ 6,5x 475/800/230													
15.5															
40															

2) CP: Control points of hot runner manifold

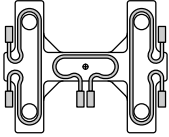
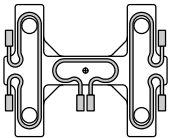
Item	L	B	I1 (min.-max.)	I2 (min.-max.)	d1	d2	d3	S (min.-max.)	T (min.-max.)	R	CP ²⁾	Power total watts	Manifold heater item no.	d	Type
EH 6000/ HMT4	334	= 2 x I1 + 100	> 147,5 - 160	> 118.75 - 131.25	12	12	12	86 - 116	15 - 160	0	3	230V / 6200 W	4x EH 5030/MH-FLEX/ 6,5x 750/1150/230 2x EH 5030/MH-FLEX/ 6,5x 475/800/230	37	
	15.5														
	359									40		230V / 6400 W	4x EH 5030/MH-FLEX/ 6,5x 800/1200/230 2x EH 5030/MH-FLEX/ 6,5x 475/800/230		
	0														
	384									15.5		230V / 6600 W	4x EH 5030/MH-FLEX/ 6,5x 850/1250/230 2x EH 5030/MH-FLEX/ 6,5x 475/800/230		
	40														
	409									0		230V / 6800 W	4x EH 5030/MH-FLEX/ 6,5x 900/1300/230 2x EH 5030/MH-FLEX/ 6,5x 475/800/230		
	15.5														
434	40	230V / 7000 W	4x EH 5030/MH-FLEX/ 6,5x 950/1350/230 2x EH 5030/MH-FLEX/ 6,5x 475/800/230												
0															
459	15.5	230V / 7200 W	4x EH 5030/MH-FLEX/ 6,5x 1000/1400/230 2x EH 5030/MH-FLEX/ 6,5x 475/800/230												
40															
484	0	230V / 7400 W	4x EH 5030/MH-FLEX/ 6,5x 1050/1450/230 2x EH 5030/MH-FLEX/ 6,5x 475/800/230												
15.5															
	40														
EH 6000/ HMT4	159	= 2 x I1 + 100	> 160 - 172,5	37,5 - 43.75	12	12	12	86 - 116	15 - 160	0	3	230V / 4400 W	4x EH 5030/MH-FLEX/ 6,5x 400/650/230 2x EH 5030/MH-FLEX/ 6,5x 525/900/230	37	
	15.5														
	184									40		230V / 4800 W	4x EH 5030/MH-FLEX/ 6,5x 450/750/230 2x EH 5030/MH-FLEX/ 6,5x 525/900/230		
	0														
	209									15.5		230V / 5200 W	4x EH 5030/MH-FLEX/ 6,5x 500/850/230 2x EH 5030/MH-FLEX/ 6,5x 525/900/230		
	40														
	234									0		230V / 5600 W	4x EH 5030/MH-FLEX/ 6,5x 550/950/230 2x EH 5030/MH-FLEX/ 6,5x 525/900/230		
	15.5														
	259									40		230V / 5800 W	4x EH 5030/MH-FLEX/ 6,5x 600/1000/230 2x EH 5030/MH-FLEX/ 6,5x 525/900/230		
	0														
	284									15.5		230V / 6000 W	4x EH 5030/MH-FLEX/ 6,5x 650/1050/230 2x EH 5030/MH-FLEX/ 6,5x 525/900/230		
	40														
	309									0		230V / 6200 W	4x EH 5030/MH-FLEX/ 6,5x 700/1100/230 2x EH 5030/MH-FLEX/ 6,5x 525/900/230		
	15.5														
	334									40		230V / 6400 W	4x EH 5030/MH-FLEX/ 6,5x 750/1150/230 2x EH 5030/MH-FLEX/ 6,5x 525/900/230		
	0														
359	15.5	230V / 6600 W	4x EH 5030/MH-FLEX/ 6,5x 800/1200/230 2x EH 5030/MH-FLEX/ 6,5x 525/900/230												
40															
384	0	230V / 6800 W	4x EH 5030/MH-FLEX/ 6,5x 850/1250/230 2x EH 5030/MH-FLEX/ 6,5x 525/900/230												
15.5															
409	40	230V / 7000 W	4x EH 5030/MH-FLEX/ 6,5x 900/1300/230 2x EH 5030/MH-FLEX/ 6,5x 525/900/230												
0															
434	15.5	230V / 7200 W	4x EH 5030/MH-FLEX/ 6,5x 950/1350/230 2x EH 5030/MH-FLEX/ 6,5x 525/900/230												
40															
459	0	230V / 7400 W	4x EH 5030/MH-FLEX/ 6,5x 1000/1400/230 2x EH 5030/MH-FLEX/ 6,5x 525/900/230												
15.5															
484	40	230V / 7600 W	4x EH 5030/MH-FLEX/ 6,5x 1050/1450/230 2x EH 5030/MH-FLEX/ 6,5x 525/900/230												
15.5															
	40														

2) CP: Control points of hot runner manifold

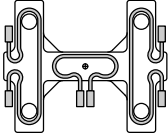
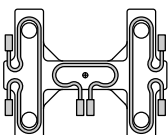
Item	L	B	I1 (min.-max.)	I2 (min.-max.)	d1	d2	d3	S (min.-max.)	T (min.-max.)	R	CP ²⁾	Power total watts	Manifold heater item no.	d	Type
EH 6000/ HMT4	159	= 2 x 11 + 100	> 172,5 - 185	37,5 - 43.75	12	12	12	86 - 116	15 - 160	0	3	230V / 4550 W	4x EH 5030/MH-FLEX/ 6,5x 400/650/230 2x EH 5030/MH-FLEX/ 6,5x 575/975/230	37	
	15.5														
	40			230V / 4950 W						4x EH 5030/MH-FLEX/ 6,5x 450/750/230 2x EH 5030/MH-FLEX/ 6,5x 575/975/230					
	0														
	15.5			230V / 5350 W						4x EH 5030/MH-FLEX/ 6,5x 500/850/230 2x EH 5030/MH-FLEX/ 6,5x 575/975/230					
	40														
	0			230V / 5750 W						4x EH 5030/MH-FLEX/ 6,5x 550/950/230 2x EH 5030/MH-FLEX/ 6,5x 575/975/230					
	15.5														
	40			230V / 5950 W						4x EH 5030/MH-FLEX/ 6,5x 600/1000/230 2x EH 5030/MH-FLEX/ 6,5x 575/975/230					
	0														
	15.5			230V / 6150 W						4x EH 5030/MH-FLEX/ 6,5x 650/1050/230 2x EH 5030/MH-FLEX/ 6,5x 575/975/230					
	40														
	0			230V / 6350 W						4x EH 5030/MH-FLEX/ 6,5x 700/1100/230 2x EH 5030/MH-FLEX/ 6,5x 575/975/230					
	15.5														
	40			230V / 6550 W						4x EH 5030/MH-FLEX/ 6,5x 750/1150/230 2x EH 5030/MH-FLEX/ 6,5x 575/975/230					
	0														
15.5	230V / 6750 W	4x EH 5030/MH-FLEX/ 6,5x 800/1200/230 2x EH 5030/MH-FLEX/ 6,5x 575/975/230													
40															
0	230V / 6950 W	4x EH 5030/MH-FLEX/ 6,5x 850/1250/230 2x EH 5030/MH-FLEX/ 6,5x 575/975/230													
15.5															
40	230V / 7150 W	4x EH 5030/MH-FLEX/ 6,5x 900/1300/230 2x EH 5030/MH-FLEX/ 6,5x 575/975/230													
0															
15.5	230V / 7350 W	4x EH 5030/MH-FLEX/ 6,5x 950/1350/230 2x EH 5030/MH-FLEX/ 6,5x 575/975/230													
40															
0	230V / 7550 W	4x EH 5030/MH-FLEX/ 6,5x 1000/1400/230 2x EH 5030/MH-FLEX/ 6,5x 575/975/230													
15.5															
40	230V / 7750 W	4x EH 5030/MH-FLEX/ 6,5x 1050/1450/230 2x EH 5030/MH-FLEX/ 6,5x 575/975/230													
0															
15.5															
40															
EH 6000/ HMT4	159	= 2 x 11 + 100	> 185 - 197,5	37,5 - 43.75	12	12	12	86 - 116	15 - 160	0	3	230V / 4650 W	4x EH 5030/MH-FLEX/ 6,5x 400/650/230 2x EH 5030/MH-FLEX/ 6,5x 625/1025/230	37	
	15.5														
	40			230V / 5050 W						4x EH 5030/MH-FLEX/ 6,5x 450/750/230 2x EH 5030/MH-FLEX/ 6,5x 625/1025/230					
	0														
	15.5			230V / 5450 W						4x EH 5030/MH-FLEX/ 6,5x 500/850/230 2x EH 5030/MH-FLEX/ 6,5x 625/1025/230					
	40														
	0			230V / 5850 W						4x EH 5030/MH-FLEX/ 6,5x 550/950/230 2x EH 5030/MH-FLEX/ 6,5x 625/1025/230					
	15.5														
40	230V / 6050 W	4x EH 5030/MH-FLEX/ 6,5x 600/1000/230 2x EH 5030/MH-FLEX/ 6,5x 625/1025/230													
0															
15.5	230V / 6250 W	4x EH 5030/MH-FLEX/ 6,5x 650/1050/230 2x EH 5030/MH-FLEX/ 6,5x 625/1025/230													
40															
0	230V / 6450 W	4x EH 5030/MH-FLEX/ 6,5x 700/1100/230 2x EH 5030/MH-FLEX/ 6,5x 625/1025/230													
15.5															
40															

2) CP: Control points of hot runner manifold

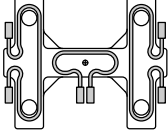
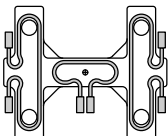
Item	L	B	I1 (min.-max.)	I2 (min.-max.)	d1	d2	d3	S (min.-max.)	T (min.-max.)	R	CP ²⁾	Power total watts	Manifold heater item no.	d	Type
EH 6000/ HMT4	334	= 2 x I1 + 100	> 185 - 197,5	> 118.75 - 131.25	12	12	12	86 - 116	15 - 160	0	3	230V / 6650 W	4x EH 5030/MH-FLEX/ 6,5x 750/1150/230 2x EH 5030/MH-FLEX/ 6,5x 625/1025/230	37	
	15.5														
	40			230V / 6850 W						4x EH 5030/MH-FLEX/ 6,5x 800/1200/230 2x EH 5030/MH-FLEX/ 6,5x 625/1025/230					
	0														
	15.5			230V / 7050 W						4x EH 5030/MH-FLEX/ 6,5x 850/1250/230 2x EH 5030/MH-FLEX/ 6,5x 625/1025/230					
	40														
	0			230V / 7250 W						4x EH 5030/MH-FLEX/ 6,5x 900/1300/230 2x EH 5030/MH-FLEX/ 6,5x 625/1025/230					
	15.5														
40	230V / 7450 W	4x EH 5030/MH-FLEX/ 6,5x 950/1350/230 2x EH 5030/MH-FLEX/ 6,5x 625/1025/230													
0															
15.5	230V / 7650 W	4x EH 5030/MH-FLEX/ 6,5x 1000/1400/230 2x EH 5030/MH-FLEX/ 6,5x 625/1025/230													
40															
0	230V / 7850 W	4x EH 5030/MH-FLEX/ 6,5x 1050/1450/230 2x EH 5030/MH-FLEX/ 6,5x 625/1025/230													
15.5															
40															
EH 6000/ HMT4	159	= 2 x I1 + 100	> 197,5 - 210	37,5 - 43.75	12	12	12	86 - 116	15 - 160	0	3	230V / 4750 W	4x EH 5030/MH-FLEX/ 6,5x 400/650/230 2x EH 5030/MH-FLEX/ 6,5x 675/1075/230	37	
	15.5														
	40			230V / 5150 W						4x EH 5030/MH-FLEX/ 6,5x 450/750/230 2x EH 5030/MH-FLEX/ 6,5x 675/1075/230					
	0														
	15.5			230V / 5550 W						4x EH 5030/MH-FLEX/ 6,5x 500/850/230 2x EH 5030/MH-FLEX/ 6,5x 675/1075/230					
	40														
	0			230V / 5950 W						4x EH 5030/MH-FLEX/ 6,5x 550/950/230 2x EH 5030/MH-FLEX/ 6,5x 675/1075/230					
	15.5														
	40			230V / 6150 W						4x EH 5030/MH-FLEX/ 6,5x 600/1000/230 2x EH 5030/MH-FLEX/ 6,5x 675/1075/230					
	0														
	15.5			230V / 6350 W						4x EH 5030/MH-FLEX/ 6,5x 650/1050/230 2x EH 5030/MH-FLEX/ 6,5x 675/1075/230					
	40														
	0			230V / 6550 W						4x EH 5030/MH-FLEX/ 6,5x 700/1100/230 2x EH 5030/MH-FLEX/ 6,5x 675/1075/230					
	15.5														
	40			230V / 6750 W						4x EH 5030/MH-FLEX/ 6,5x 750/1150/230 2x EH 5030/MH-FLEX/ 6,5x 675/1075/230					
	0														
15.5	230V / 6950 W	4x EH 5030/MH-FLEX/ 6,5x 800/1200/230 2x EH 5030/MH-FLEX/ 6,5x 675/1075/230													
40															
0	230V / 7150 W	4x EH 5030/MH-FLEX/ 6,5x 850/1250/230 2x EH 5030/MH-FLEX/ 6,5x 675/1075/230													
15.5															
40	230V / 7350 W	4x EH 5030/MH-FLEX/ 6,5x 900/1300/230 2x EH 5030/MH-FLEX/ 6,5x 675/1075/230													
0															
15.5	230V / 7550 W	4x EH 5030/MH-FLEX/ 6,5x 950/1350/230 2x EH 5030/MH-FLEX/ 6,5x 675/1075/230													
40															
0	230V / 7750 W	4x EH 5030/MH-FLEX/ 6,5x 1000/1400/230 2x EH 5030/MH-FLEX/ 6,5x 675/1075/230													
15.5															
40	230V / 7950 W	4x EH 5030/MH-FLEX/ 6,5x 1050/1450/230 2x EH 5030/MH-FLEX/ 6,5x 675/1075/230													
0															
15.5															
40															

2) CP: Control points of hot runner manifold

